



Assembly & Exercise Guide

Carefully reading and keeping the operating
Instructions before use.

F5 - Soccer Table



**CAUTION! CAREFULLY READING AND KEEPING THE OPERATING INSTRUCTIONS BEFORE USE.
NOT SUITABLE FOR CHILDREN BELOW THE AGE OF 3, AS THERE IS A CHOKING HAZARD FROM SWALLOW ABLE
SMALL BALLS.**



Congratulations! You have bought a first quality table. It is an indoor table: please assemble it and use it indoors only.

ASSEMBLY AND DISMANTLING MUST ONLY BE CARRIED OUT BY ADULTS.

IMPORTANT: Once assembled your table is quite wide and may not fit through your doors. For this reason you should assemble it in the room you intend it to be used. Should you wish to move your table to another room, it might be necessary to remove its legs.













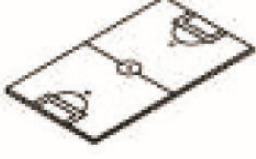

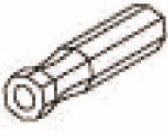

This table set is only designed for private use. For commercial use, the warranty loses its validity. Please use this game exclusively for its intended purpose.









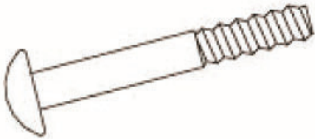
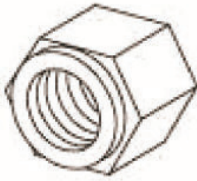

In order to ensure its long life and continued playing appeal, we recommend that you follow the simple instructions below:

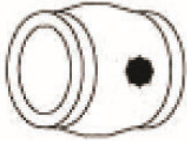
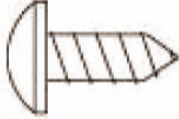
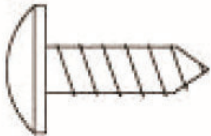
- (1) Your table has been manufactured for indoor playing: do not leave it outdoors. Rain, snow and high humidity may damage its materials. Prolonged exposure to the sun is to be avoided too, due to its ultraviolet effects which will ruin the colours.
- (2) Clean your table periodically. It is sufficient to wipe its surfaces using a damp cloth. For a deeper cleaning you can use any household detergent which does not contain wax or abrasives. Should you wish to furtherly improve bars smoothness, only employ a good quality silicone spray. Please be careful not to use any vegetal or any other type of grease or you run the risk of attracting dirt.
- (3) Should you pass on the table set to another person, please make sure that this person is aware of the assembly and user instructions.
- (4) Always place the table set on even and stable surfaces.
- (5) Before each use, check that all parts are functioning correctly and do not use the table set if that is not the case.
- (6) Always place a protective layer (cardboard or carpet) under the table legs to protect your floors.
- (7) **CAUTION:** To avoid any problems in the assembly or fastening of the table legs, first screw on all of the legs loosely at the same time and only tighten them later.

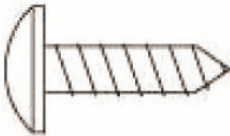
**GARLANDO DOES NOT ACCEPT ANY RESPONSIBILITY FOR DAMAGES RESULTING FROM DISREGARDING THESE INSTRUCTIONS.
SUBJECT TO COLOUR CHANGES AND TECHNICAL CHANGES. PLEASE KEEP THIS PACKAGING FOR POSSIBLE FUTURE
CORRESPONDENCE.**

Components

<p>P1 = 2x</p>  <p>Side panel</p>	<p>P2 = 2x</p>  <p>End panel</p>	<p>P3 = 1x</p>  <p>Playfield</p>	<p>P4A = 2x</p>  <p>Left leg</p>
<p>P4B = 2x</p>  <p>Right leg</p>	<p>P5 = 2x</p>  <p>Round support brace</p>	<p>P6 = 8x</p>  <p>Handle</p>	<p>P7 = 3x</p>  <p>Support brace</p>
<p>P8 = 2x</p>  <p>Ball entry</p>	<p>P9 = 2x</p>  <p>Ball catcher</p>	<p>P10 = 8x</p>  <p>Endcap</p>	<p>P11 = 2x</p>  <p>Score counter</p>
<p>C1 = 2x</p>  <p>5 players rod</p>	<p>C2 = 4x</p>  <p>1 + 3 players rod</p>	<p>C3 = 2x</p>  <p>2 players rod</p>	<p>C4 = 16x</p>  <p>Shock absorber</p>

<p>C5 = 32x</p>  <p>Plastic washer</p>	<p>C6 = 26x</p>  <p>Screw for player</p>	<p>C7 = 26x</p>  <p>Nut for player</p>	<p>C8 = 11x</p>  <p>Player</p>
<p>C9 = 11x</p>  <p>Player</p>	<p>C10 = 4x</p>  <p>Goalie stopper</p>	<p>H1 = 8x</p>  <p>Screw</p>	<p>H2 = 6x</p>  <p>Screw</p>
<p>H3 = 3x</p>  <p>Support rod</p>	<p>H4 = 6x</p>  <p>Nut</p>	<p>H5 = 12x</p>  <p>Screw</p>	<p>H6 = 24x</p>  <p>Screw</p>
<p>H7 = 24x</p>  <p>Washer</p>	<p>A1 = 2x</p>  <p>Ball</p>	<p>A2 = 2x</p>  <p>Allen key 4mm</p>	<p>A3 = 1x</p>  <p>Allen key 6mm</p>

POSITION OF RODS

The -table is equipped with 4 rods for each side/ team:

- Goalkeeper (1 player rod) at the end of the playfield **Position A**
- Defence (2 player rod) in front of the same colour goalkeeper **Position B**
- Mid-fielder (5 player rod) in the middle of the playfield , in front of the 5 player rod of the opposite colour **Position C**
- Forward (3 player rod) in front of the 2 player rod of the opposite colour **Position D**

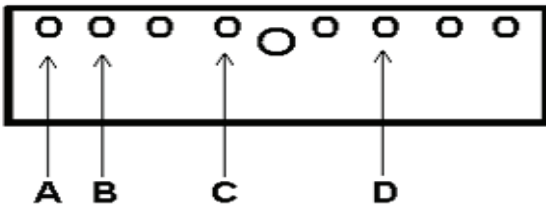

STEP 1

DIAGRAM OF FINAL ASSEMBLY

Red player side

Red counter

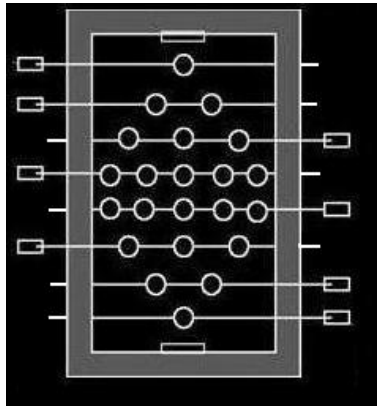

Blue player side

Blue counter

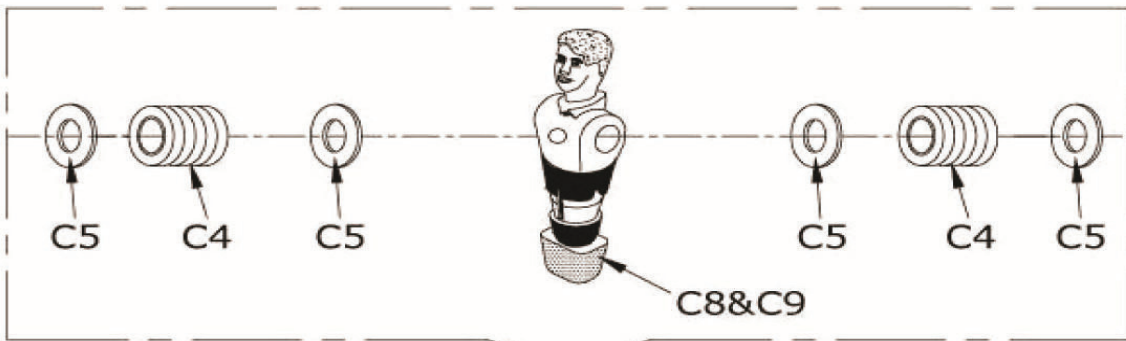

	R1 5-Homeplayer-Rod	1x
	R2 3-Homeplayer-Rod	1x
	R3 2-Homeplayer-Rod	1x
	R4 1-Homeplayer-Rod	1x
	R5 5-Visitorplayer-Rod	1x
	R6 3-Visitorplayer-Rod	1x
	R7 2-Visitorplayer-Rod	1x
	R8 1-Visitorplayer-Rod	1x

STEP 2

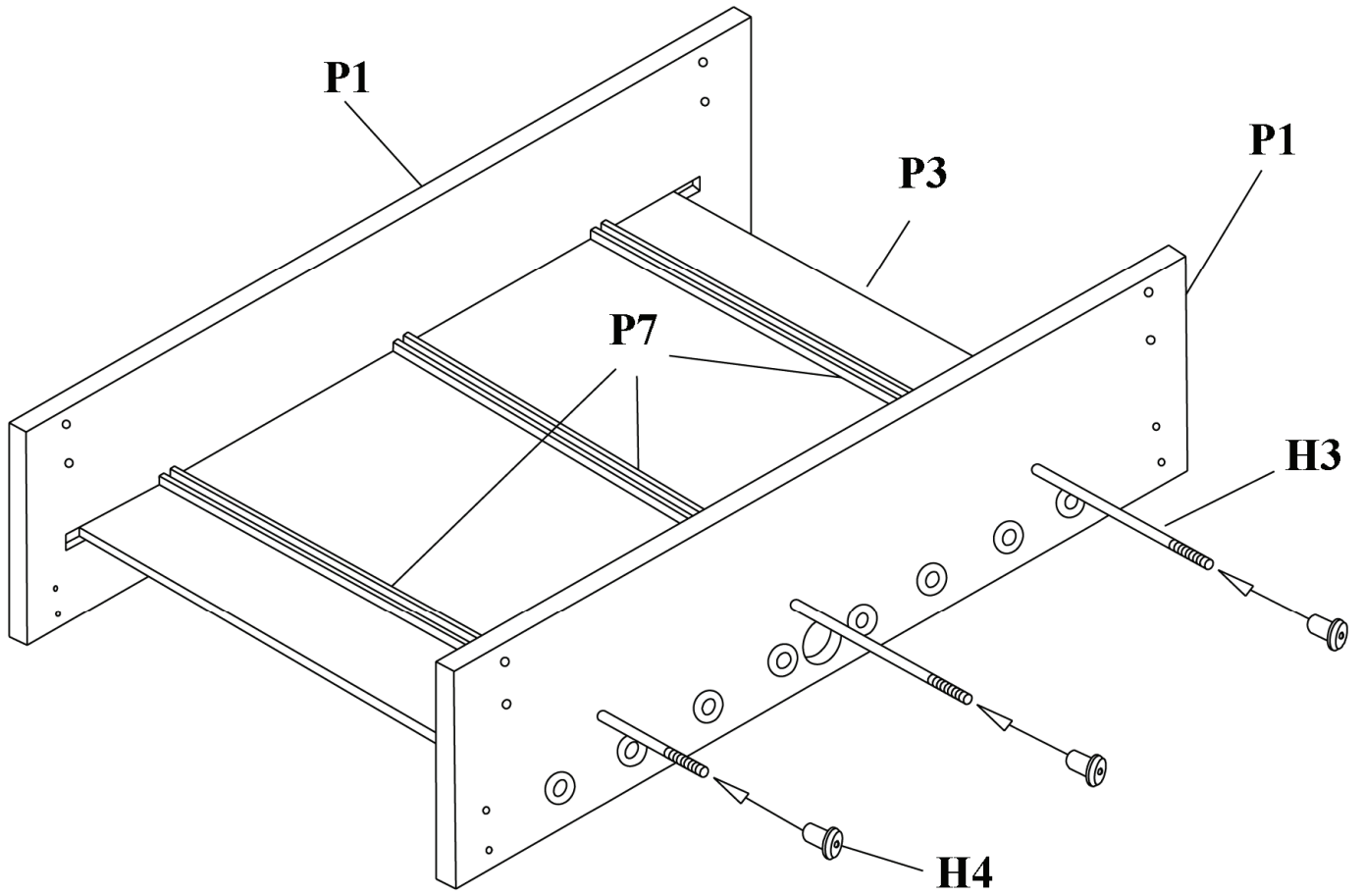

STEP 3

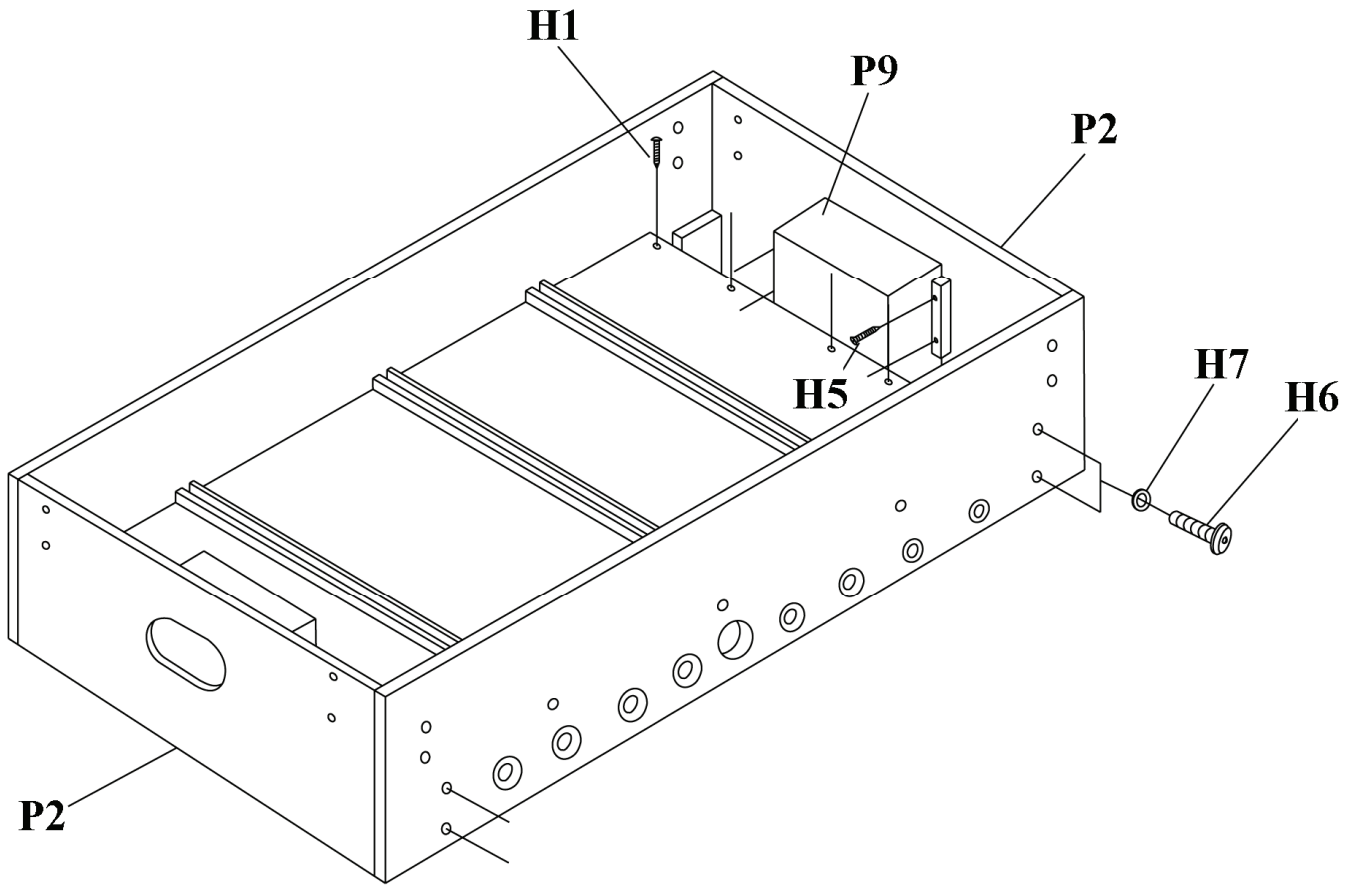

STEP 4

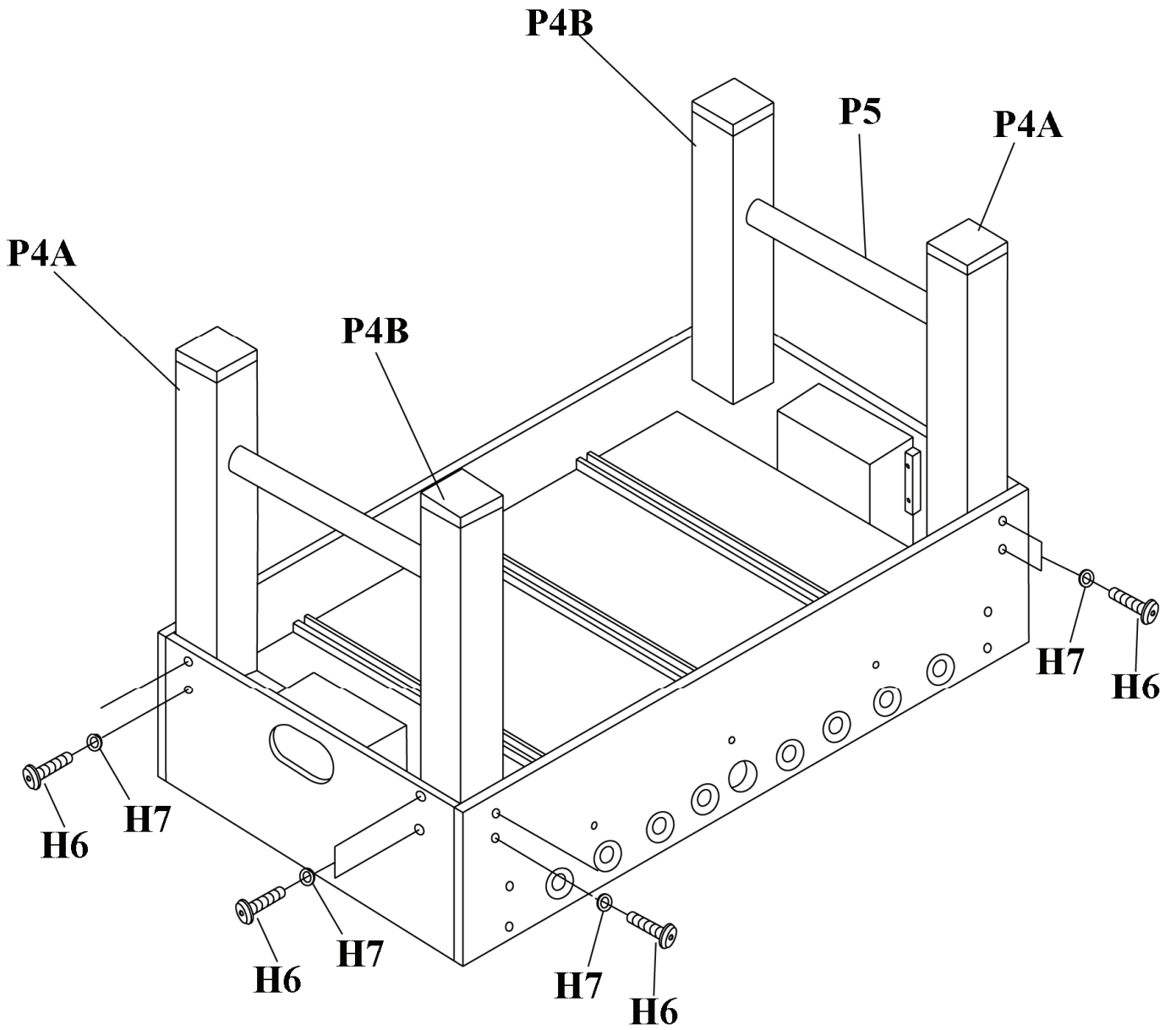

STEP 5

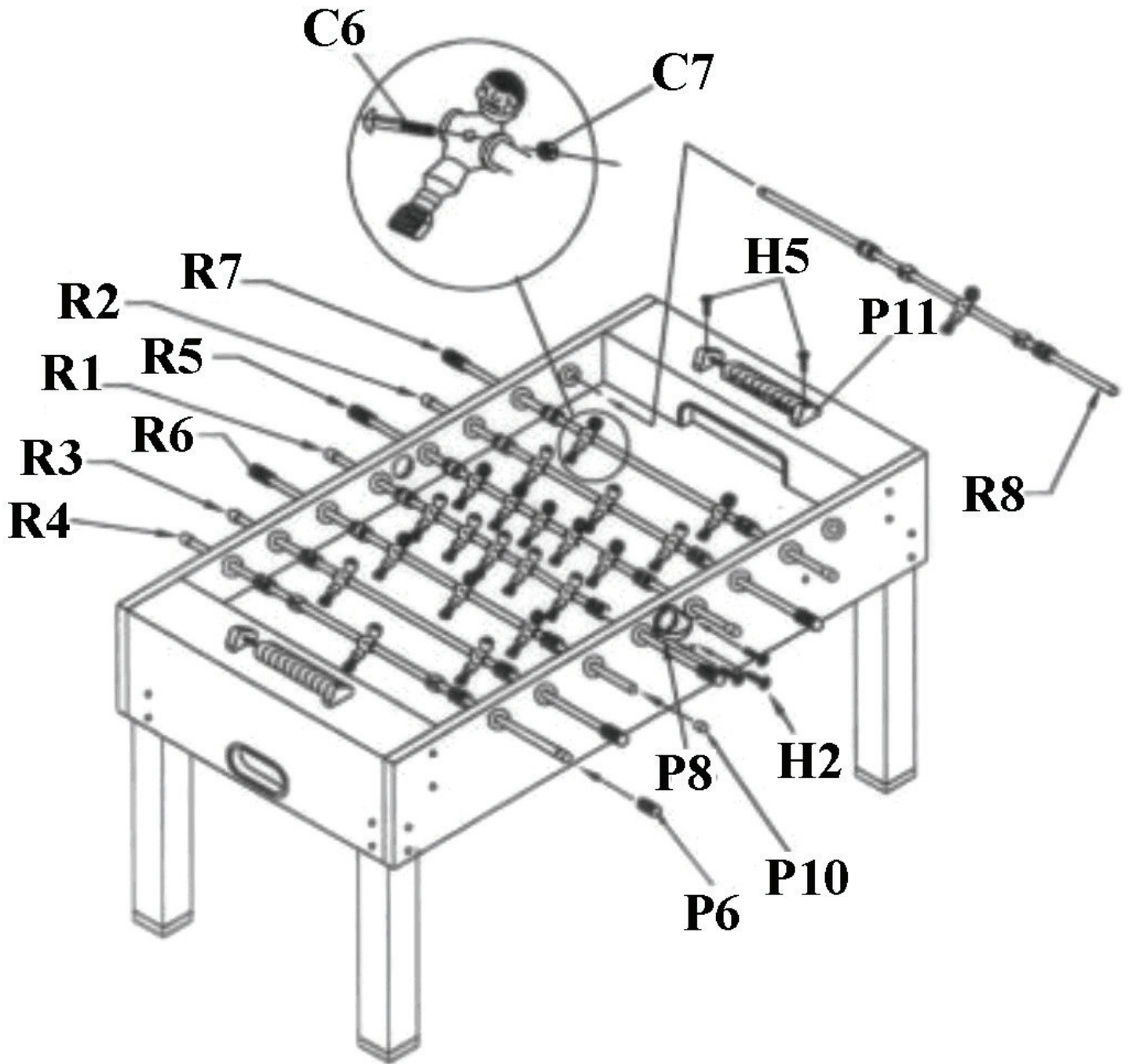

SOCCER TABLE DEMOLITION AND HARMFUL MATERIAL REMOVAL

Demolition

The Soccer table doesn't require any particular care for the demolition since it doesn't have any parts produced with dangerous materials. The materials are:

The materials are: **Wood, MDF, Steel, Aluminium, ABS, PP, PE, PVC.**

These materials are present in the following parts:

Frame: Wood, MDF, Steel.

Legs: Wood, Steel

Playfield: Wood

Rods: Steel, PP.

Accessories: ABS, PE, PVC.

Finishing: Aluminium, ABS.

During Soccer Table demolition we suggest the sharing of the different materials and their removal in authorized collection centre for their recycling.

Removal of harmful materials

The Soccer Table doesn't produce any harmful substances.

Guarantee conditions

The guarantee period begins with the date of the invoice or delivery.

Repairs or any returns are **ONLY** possible in the original packing with proof of purchase and assembly and exercise guide. Otherwise a charge will be made!

The guarantee covers faults in manufacturing and materials. It does not cover damage caused by incorrect use or *force majeure* or natural wear and tear.

During the period covered by the guarantee, you are entitled to have repairs carried out. This means that we will remedy any faults free of charge up to the expiry of the guarantee period valid at the time of purchase. After the expiry of the guarantee period, a charge will be made for carriage and packing costs. If necessary, we will replace the article as a whole or parts thereof. If our efforts during the period of the guarantee valid at the time of purchase are not successful or if repair is not worthwhile, you also have the right at your choice to cancel the contract (conversion) or to receive a reduction in the purchase price (redhibition).

Please notify us immediately of any fault. Obvious faults, including transport damage, will only be recognized by us when reported to us within one week of delivery at the latest

Description of fault on return of goods

If any faults occur, please contact the dealer from whom you purchased the article and then return it to him. Please make sure that it is properly packed (original packing) and enclose your receipt and a detailed description of the fault.

Please note!

Complaints can **ONLY** be processed when this product is returned in the original packing – no exceptions (please enclose the assembly guide/instructions for use, a detailed description of the fault and receipt. Only the original packing guarantees adequate transport protection of the goods and should therefore be stored during the guarantee period.

Importer:

GARLANDO S.p.A.

Via Regione Piemonte 5, Zona Ind. D1

15068 - Pozzolo Formigaro (AL) Italy

Tel. +39.0143.318500

Fax +39.0143.318557

info@garlando.it

www.garlando.it